

# WorkLink

Multi-Tasking Table





WORLINK is for the dynamic fast moving Organization,  
where time and efficiency is a valuable asset.

WorkLink



## WHAT WOULD MAKE THE TEAM MORE EFFICIENT?

We acknowledge the importance of tables, we all need lots of tables, for meeting purposes, workstation, meeting rooms and even pantry area.

The name says it all... WORKLINK.  
We link all your works together, seamless activities for different usage and functions.



Work, collaborate and discuss

# COLLABORATION.



## One Table, many usage.

Be it a formal or casual meeting or gathering, WORKLINK simply link all together. Cluster of tables could be place throughout the office space, this way it promotes better communication flow.

With WORKLINK, there is no need to have customized meeting tables and in a long run it helps to save on the operating cost.

FUNCTIONAL.



Group brainstorming and discussion

# SOLUTION.

## A Dynamic Solution.

A simple table that is meant for all sort of functions and usage, isn't it a obvious intelligent cost saving solution?

Need not to break your Organization's budget but get the solution that is one for all, all for one.



For individual work focus and privacy

TABLE selections



**SD-CTC16**  
Dia1600 x H720mm

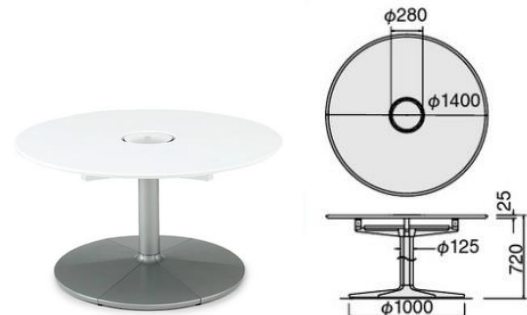

**SD-CTC14**  
Dia1400 x H720mm



**SD-CTC14H**  
Dia1400 x H1000mm

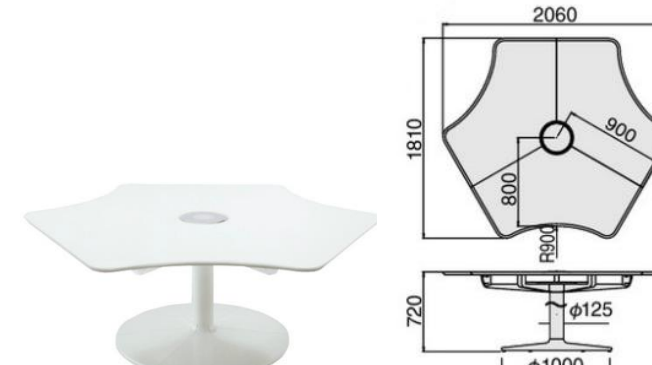

**SD-CTT169**  
Dia1600 x H720mm

Table top



Leg selection



PRIVACY PANELS options



**Acrylic Curve Panel**  
**SDV-CTW83G**  
W770xD160xH350  
**SDV-CTW73G**  
W670xD160xH350

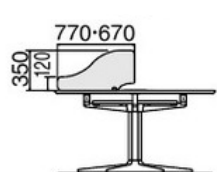

**Privacy Panel**  
**SDV-CT95**  
W900xThk28xH460  
**SDV-CT85**  
W800xThk28xH460  
**SDV-CTS105**  
W1000xThk28xH460



**Privacy Curve Panel**  
**SDV-CTW108**  
W1000xThk28xH820  
**SDV-CTW98**  
W900xThk28xH820  
**SDV-CTWS118**  
W1100xThk28xH820

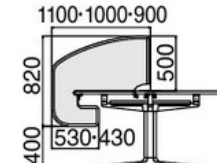

**Privacy Panel (Extended)**  
**SDV-CT139**  
W1350xThk28xH905  
**SDV-CT129**  
W1250xThk28xH905  
**SDV-CTS139**  
W1350xThk28xH905

Fabric Colors selection



ACCESSORIES options



**SDA-CTJT16**  
Add on Table Tray



**SDS-CTC16**  
Add on Underneath  
Table Tray



**SDA-CTPC10**  
CPU Holder



**SDA-CTH10**  
Hook



**SDV-HGVC10**  
A4 Papers Tray  
W338xD230xH63



**SDV-HGVC11**  
A4 Box  
W80xD225xH268



**SDV-HGVC12**  
A4 Pocket  
W338xD75xH165



**SDV-HGVC6T**  
Small Stationery  
Holder  
W598xD135xH140



**Hanging Shelf**  
**SDV-HGVC8**  
W798xD135xH63  
**SDV-HGVC6**  
W598xD135xH63  
**SDV-HGVC4**  
W398xD135xH63

ADD-ON options



**SD-CT53C**  
Personal Storage Cart  
with Castors

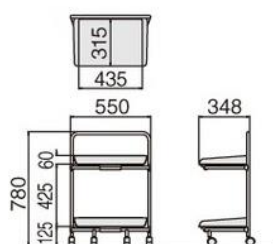

**SD-CTBK10**  
Personal Mobile Cart

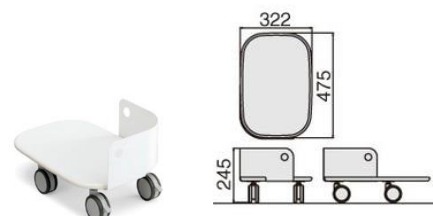

**SD-CT64T3S**  
Personal Storage Cabinet with Castors

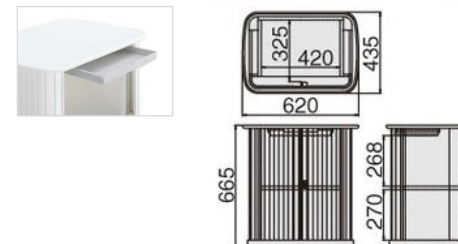

Top board color selections



Carcass color selections



**KOKUYO**

Japan | China | Hong Kong | Singapore | Malaysia | Thailand | India | Indonesia

[www.kokuyo.com/en/](http://www.kokuyo.com/en/)

**OSAKA** +81 66976-8222 | **BEIJING** +86 10 6588 7040 | **SHANGHAI** +86 21 6136 3288 | **SHENZHEN** +86 755 8207 2818  
**DALIAN** +86 411 8370 2660 | **TIANJING** +86 22 2311 0108 | **HONG KONG** +85 22522 3292 | **SINGAPORE** +65 6222 7535 |  
**NEW DELHI** +91 22 2820 9681 | **BANGKOK** +66 2 2645 100 | **KUALA LUMPUR** +60 3 2161 4060 | **JAKARTA** +62 021 2992 3322 |  
**QUEENSLAND** +61 7 3216 1683