

KOKUYO

Japan | China | Hong Kong | Singapore | Malaysia | Thailand | India | Indonesia

www.kokuyo.com/en/



- Concentration space
- Communication space
- Refreshment space
- Personal space
- Lighthearted space
- Aggregation space
- Mode change space

「brackets」

「brackets lite」

Creativity comes with design inspiration...



「brackets」
combination high-backed Sofa



Many possibilities,
Unlimited options.

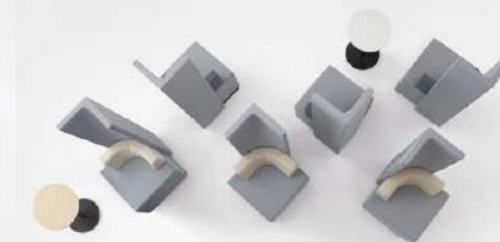



An ideal set-up for group TV conference and discussion.



Ideal for waiting area or even a personal space.



Time for group discussion, create islands for better collaboration.



Seamless configuration, arrange and install.



The finest details and design from Japan.



Meant for the dynamic Organization.

The Social Connection...



「brackets lite」

informal communication table which connects office worker

The Space-saver social connection.

There is always a cross junction when people meet, greet and even a quick exchange before they move on.

Bracket Lite is the junction of social connection.

Designed to as a high table, is an ideal place when employees could have a quick exchange and catch up while in the Bracket Lite booth.

The top board is in cushion upholstery and it gives a comfortable feel when lean on it during the conversation.

Brackets Lite allows you to configure to the way you want and how you want the booth to look like just to complement your office layout and décor.

Brackets Lite also comes with low cabinet for easy storage. It works well for a touch down for writing small note of filing up of information.

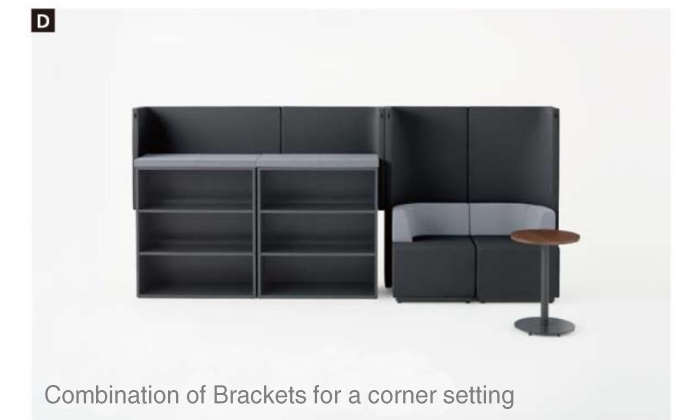
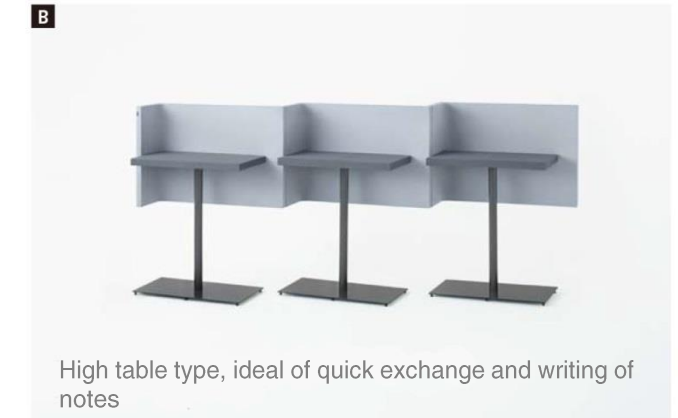



Ideal for a close-up meeting or TV Conference.



Quick exchange while standing up

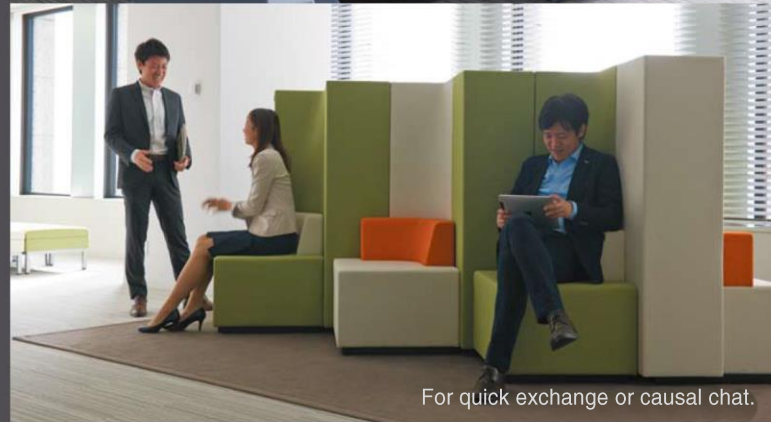

For quick exchange or causal chat.



Place it right at a corner, ideal for personal time and privacy.



No time for formal meeting, discuss over the booth to save time.

「brackets」

「brackets lite」

Plan

Video Conference Configuration



- ① CN-493AHk4C2K4C3 ×2
- ② CN-4917LHP1MK4C2 ×1
- ③ CNA-49LCD ×1
- ④ CNC-4910 ×2

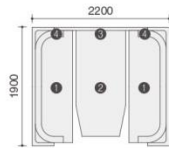

Casual Discussion Configuration



- ① CN-491FHk4C2K4C3 ×3
- ② CN-491GHk4C2K4C3 ×1
- ③ CNC-4910 ×3
- ④ CN-491Hk4C2 ×2
- ⑤ CN-49C45HP1M ×2

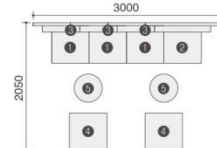

Video Conference Configuration with Brackets Lite



- ① MT-499HSk4C2 ×1
- ② MT-499TEk4C2 ×1
- ③ CN-493AHk4C2K4C3 ×2
- ④ CN-4917LHPAWK4C2 ×1
- ⑤ CNA-49LCD ×1
- ⑥ CNC-4910 ×2

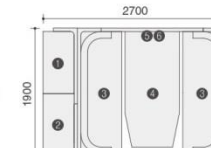

Small discussion Configuration with Brackets Lite



- ① MT-499HSk4B6 ×1
- ② MT-499HEk4B6 ×1
- ③ CN-491BHk4B6K4C3 ×1
- ④ CN-491CHk4B6K4C3 ×1
- ⑤ CN-49C45LM55 ×1
- ⑥ CNC-4910 ×2

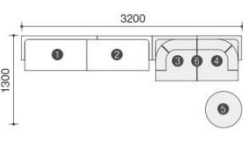

island Discussion Configuration



- ① CN-493AHk402K401 ×1
- ② CN-491BHk4B6K4C3 ×1
- ③ CN-491BHk4C2K4C3 ×1
- ④ CNC-4910 ×1
- ⑤ CN-491FHk4C2K4C3 ×1
- ⑥ CN-49C45HP1M ×1
- ⑦ CN-49C45LP1M ×1

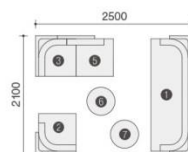

Close-up Discussion Configuration



- ① CN-491DHk4C2K401 ×1
- ② CN-491EHk4C2K401 ×1
- ③ CN-491GHk4C2K401 ×1
- ④ CN-491JHk4C2K401 ×1
- ⑤ CN-49C45LP1M ×1
- ⑥ CNC-4910 ×3

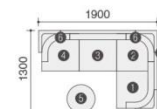

Mix and Match of selections of colors Upholstery

Please kindly refer to KOKUYO 2014 master catalog for More colors selections.



Sofa 「brackets」



CN-493AHK402K401

CN-493AH
/W1900xD650xH1400

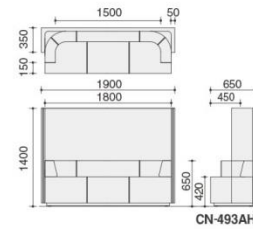

CN-493AH



CN-491BHK4B6K4C3

CN-491BH
/W650xD650xH1400

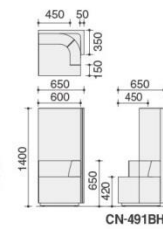

CN-491BH



CN-491CHK4C3K4C2

CN-491CH
/W650xD650xH1400

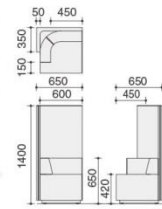

CN-491CH



CN-491DHK4C2K401

CN-491DH
/W950xD650xH1400

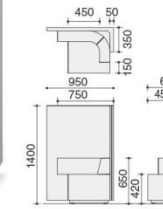

CN-491DH



CN-491EHK4C2K4C3

CN-491EH
/W650xD650xH1400

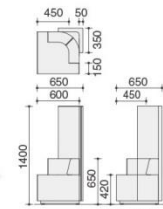

CN-491EH



CN-491FHK4C2K4C3

CN-491FH
/W900xD650xH1400

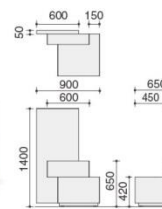

CN-491FH



CN-491GHK4C2K4C3

CN-491GH
/W1200xD650xH1400

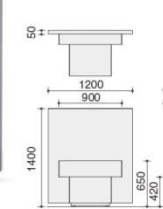

CN-491GH



ジョイント
挿入方向

CN-491JHK4C2K4C3

CN-491JH
/W650xD650xH1400

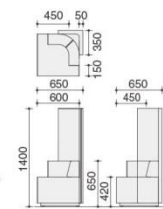

CN-491JH



CN-491HK4C2

CN-491H
/W600xD600xH420

CN-491H

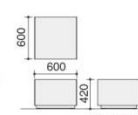

CN-491H

Sofa and Panel fabric Combination



option



CNC-4910

It can be connected easily. When you open the KOKUYO tag part of the back panel side Panels are connected using the nut hole.

CNC-4920

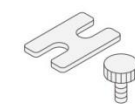

Connector parts are available to join both cushions seats together.

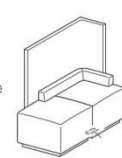

CN-491DH+CN-491H

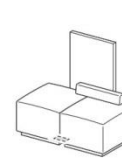

CN-491FH+CN-491H

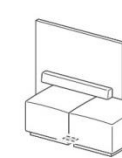

CN-491GH+CN-491H

Table 「brackets」



CN-4917LHP1MK4C2

CN-4917LHPAW-P1M-M55
/W1500xD1750xH1400

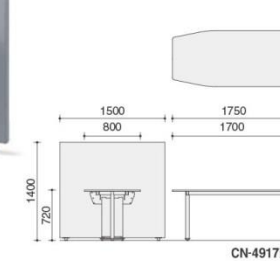

CN-4917LH



CN-4917SHP1MK4C2

CN-4917SHPAW-P1M-M55
/W900xD1750xH1400

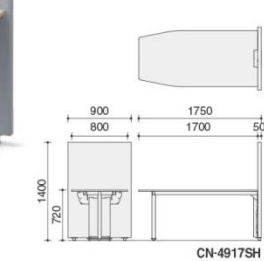

CN-4917SH



CN-4916M55

CN-4916PAW-P1M-M55
/W800xD1600xH720

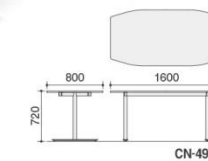

CN-4916



CN-49C45HM55

CN-49C45HPAW-P1M-M55
/φ450xH720

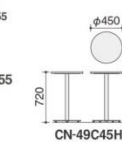

CN-49C45H



CN-49C45LPAW

CN-49C45LPAW-P1M-M55
/φ450xH620

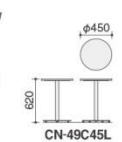

CN-49C45L

Table Top selections



Panels fabric colors selections

option



CNA-49LCD

Load capacity at 8kg, suitable for 27 inches monitor. Running cables are conceal in the trunking



MTW-WC10P81N

Install up to 2 for per table

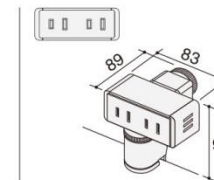

SDA-ISEJ131N

Different variations of socket. Install up to 2 for per table

Mounting of wireless Lan

Possible to mount wireless Lan

1. When there is a limited communication settings. Radio wave can be limited.
2. Lack of privacy due to eavesdropping from the outside thus can be prevented



Wireless Lan can be install easily. Simple just connect to the wiring trunking running under the table top and relocating is easy.

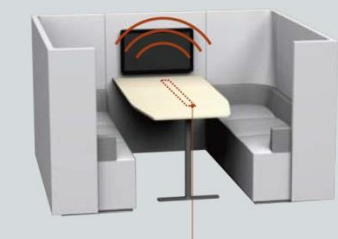
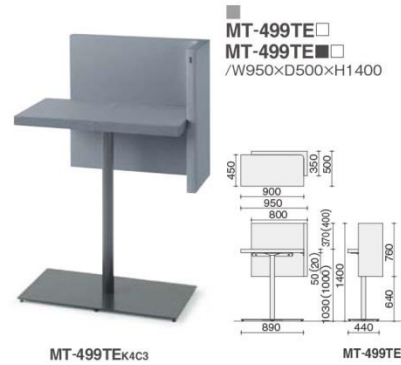
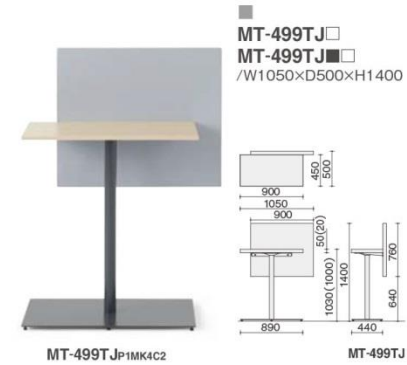
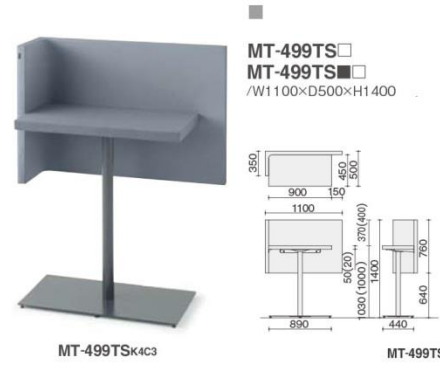

Table 「brackets lite」



The top board is in cushion finished that allows leaning While having conversation. The material is also water-repellent coating, just wipe away when spill on the top board.

option



BB-T490
Ideal for writing, to place drink cup



MTA-490TS
Suitable to place technology gadget



MTA-490EJ141
MTA-AF
Mounting of socket

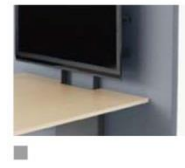

MTA-490D40
● Load capacity 15kg
● Support for VESA200 x 100 or more

Shelf 「brackets lite」

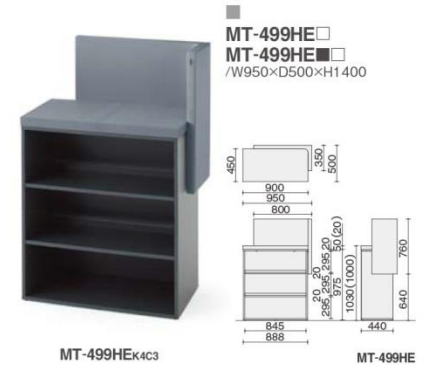
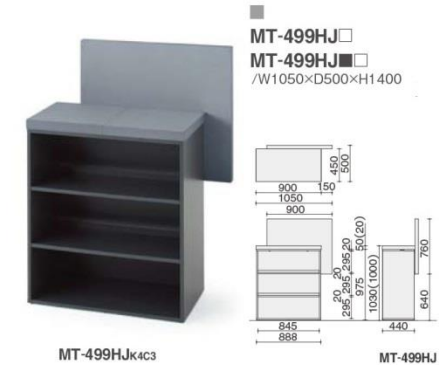
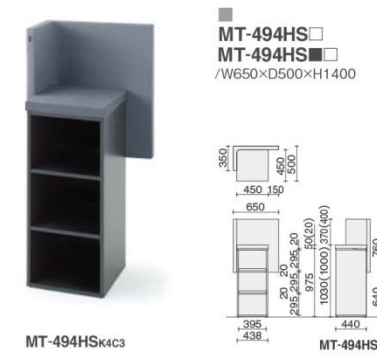

For displaying of magazines



For filing purpose



For item storage

Panels fabric colors / Table Top colors selections

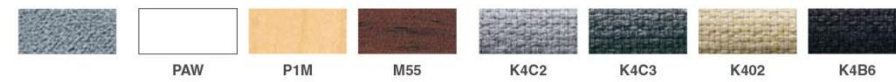

Table Shelf
Panel / sound-absorbing urethane, plywood, MDF, polyurethane foam Melamine top board / particle board, melamine veneer Leg / steel, powder coating Shelf / print paper, plywood, particle board

Counter Table
Top / particle board, melamine veneer Leg / steel, powder coating Panel / sound-absorbing urethane, plywood, MDF, polyurethane foam

Option
Whiteboard tray / acrylic, veneer Tablet Stands / steel, powder coating LCD mounting bracket / steel, powder coating

「brackets」 Message

The Environment that allows free discussion without the interfering of the surrounding.

With the increase of open space concept, the aim is to encourage collaboration and interaction between workers. However, there is a lack profound research on how our daily message was not able to transmitted through based on the environments factor.

With the target of 300 workers who are involved in research and developments, it was discovered that these places where people could gather or take a break achieved more than what it was intent to be, they promote interaction and increase collaboration efforts.

Healing of open fatigue, improve the quality of discussion "Brackets".

The Brackets has the capabilities of reduce unwanted noise from the surrounding. The panel is built in Sound-absorbing Urethane Ru. And the height Of the panel is 1400mm height as it gives you a wrapped up feeling thus enclosed and kept all the message within the cubicle.



Brackets is flexible and can be configure according to the way you want it.

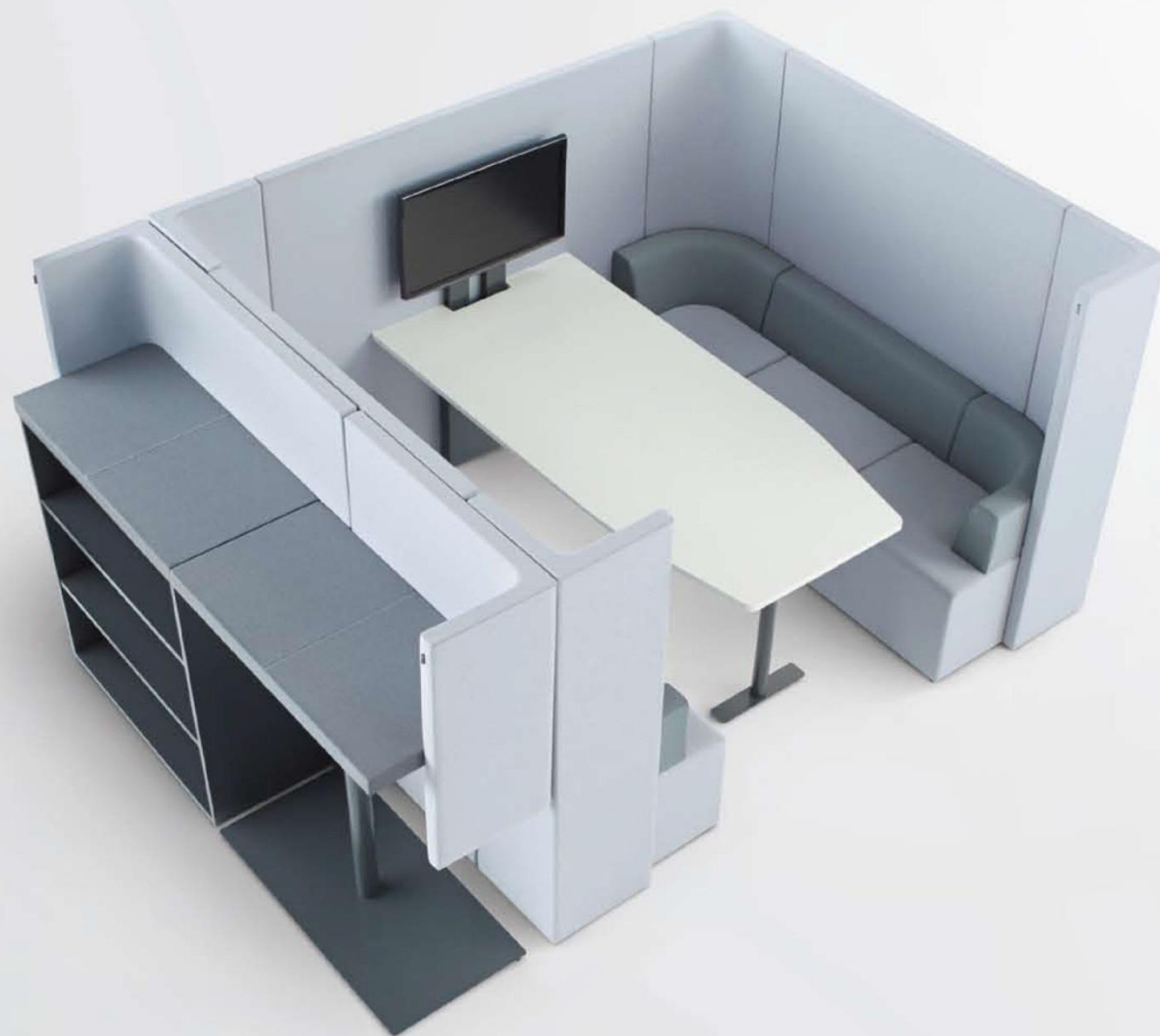
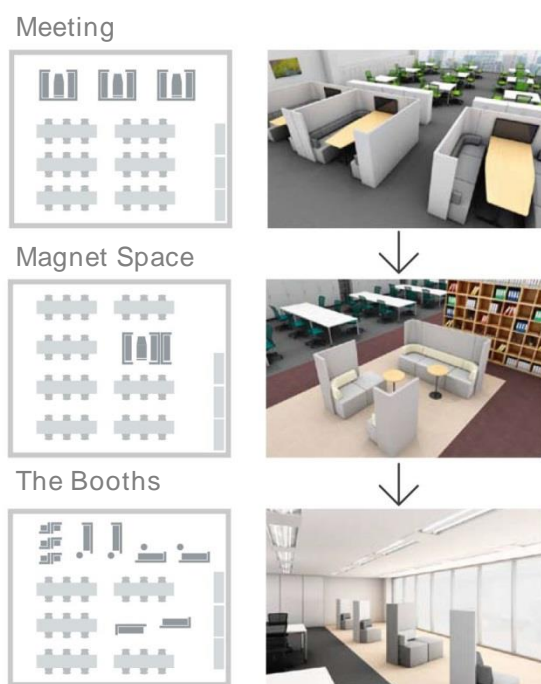
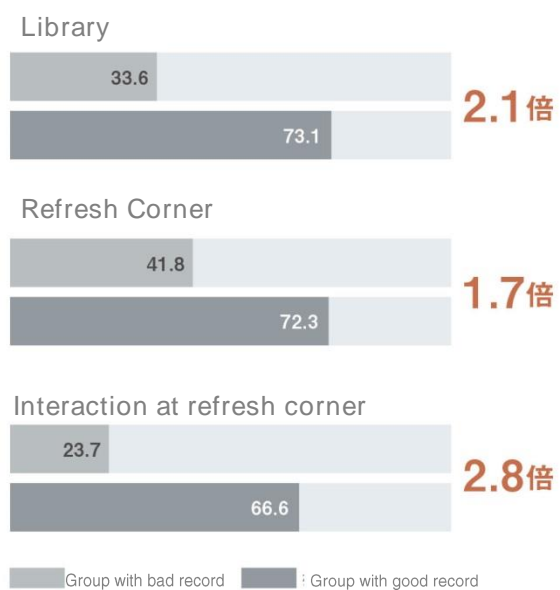

To create an ambient motion that look into prevent of unwanted noise and line of sight

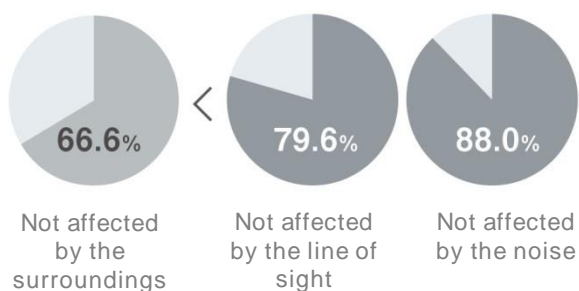

To enhance the creativity of worker, ingenuity and attention to details. Brackets is designed to take into account of legs room, easy of getting out and in the cubicle.

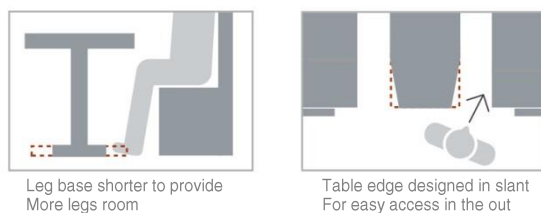

Designed by NENDO for KOKUYO

For more information, and comprehensive products information on the product specifications, dimensions, finishes, Please kindly contact your local distributor or any of the KOKUYO's affiliated partners. Above specifications is correct at the time of printing, any amendments and changes will not be notify.